



# Tilt Stand Mounting Guide

T-L462 & T-LBK462 Models

Copyright © Topaz Systems Inc. All rights reserved.

For Topaz Systems, Inc. trademarks and patents, visit [www.topazsystems.com/legal](http://www.topazsystems.com/legal).

## Table of Contents

Overview.....	3
List of Included Parts .....	3
Pad Mounting Instructions .....	4
Surface Mounting Instructions.....	9

## Overview

The Topaz Tilt Stand (A-TSL1-1) is designed to hold Topaz LCD signature pads. If desired, the stand can be securely mounted on either the counter or the wall. With the tilt stand's 360 degree rotation and up-to-45 degree tilt, your signature pad can be easily positioned during the signing process.

The tilt stand can be used with the following pads (model numbers beginning with):







T-L460, T-LBK460 (SigLite LCD 1x5)	T-LBK755 (SignatureGem LCD 4x3)
TM-LBK460 (SigLite LCD 1x5 MSR)	TM-LBK755 (SignatureGem LCD 4x3 MSR)
T-L462, T-LBK462 (SignatureGem LCD 1x5)	T-LBK766 (SignatureGem LCD 4x5)
TF-LBK463 (IDLite LCD 1x5)	TM-LBK766 (SignatureGem LCD 4x5 MSR)
TF-LBK464 (IDGem LCD 1x5)	T-LBK57GC (SigGem Color 5.7)
T-LBK750 (SigLite LCD 4x3)	TM-LBK57GC (SigGem Color 5.7 MSR)
TM-LBK750 (SigLite LCD 4x3 MSR)	T-LBK43LC (SigLite Color 4.3)

To view the mounting guides for the different signature pad models listed above, visit the page [www.topazsystems.com/tsguides](http://www.topazsystems.com/tsguides), and select the correct mounting guide for your model number (listed on the back of your signature pad).

## List of Included Parts

The following parts are included with the Topaz Tilt Stand.

**Note: Not all parts will be used with all signature pad models.**

	4x - Long Panhead Screw (For Surface Mounting)
	4x – Medium Plastite Screw
	4x – Small Flathead Screw
	4x – Small Nut (For Surface Mounting)
	4x – Small Split Washer (For Surface Mounting)
	1x – Allen Key

## Pad Mounting Instructions

- 1) The following instructions are for use with the specific signature pad models listed below:

T-L462-HSB-R  
T-LBK462-HSB-R  
T-LBK462-BSB-R

T-L462-B-R  
T-LBK462-B-R

If you have a different model number listed on the back of your signature pad (see Page 3 for compatible model series), visit [www.topazsystems.com/tsguides](http://www.topazsystems.com/tsguides) for all mounting guides.

- 2) Determine which mounting holes to use on the tilt stand. For the model numbers listed above in Step 1, use the four middle holes labeled “2” in the diagram below.

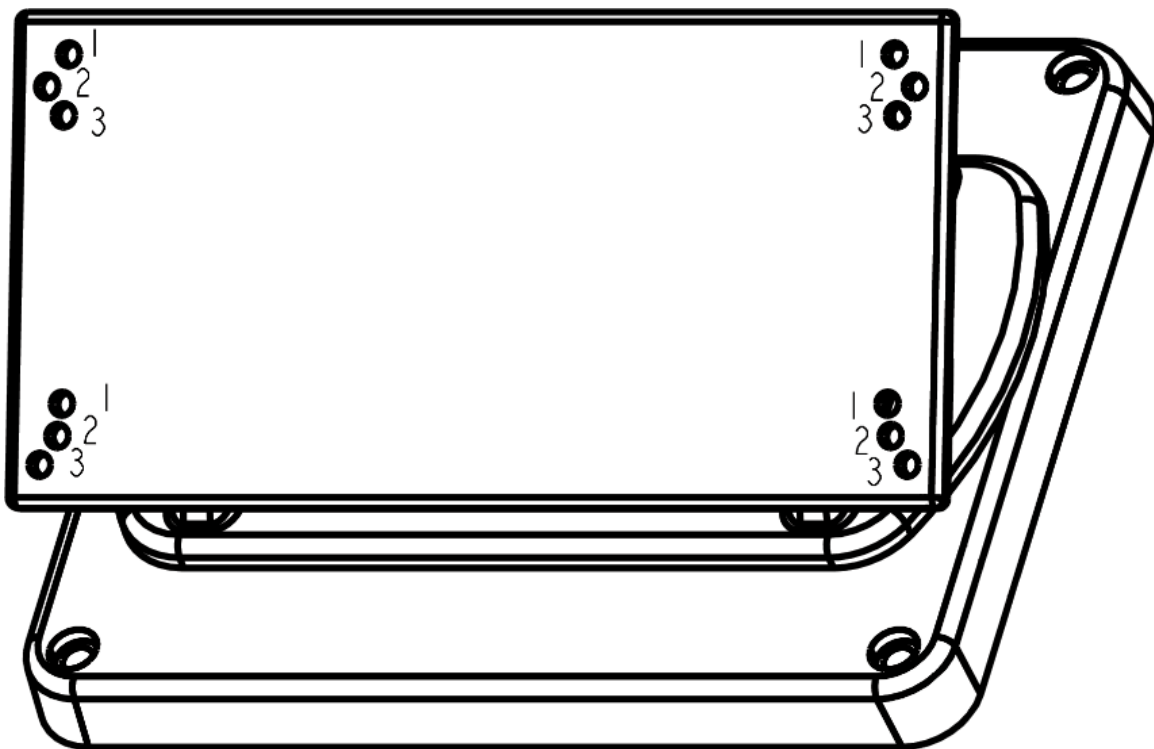

- 3) Remove the two rubber feet from the back of the pad circled in red below to reveal the screws underneath. The rubber feet are attached to the pad with a light adhesive, so use something thin to pry them off.



- 4) Using a small Phillips screwdriver (not included), remove the four screws circled below. Keep the small black screws (circled in blue below) separate from the small silver screws (circled in red below). The small silver screws will be reused in Steps 7 and 8 on Pages 7 and 8.

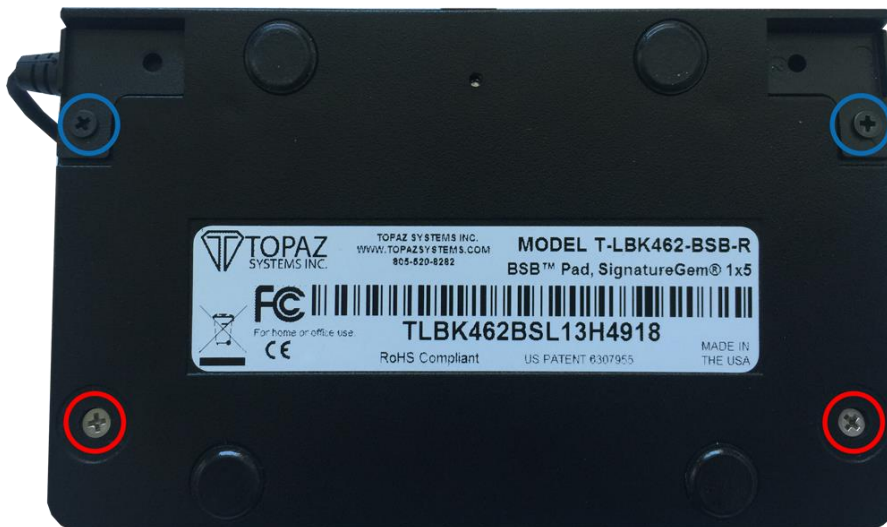

- 5) Lay the signature pad on the top of the tilt stand as it would be if in use. Then, flip both the signature pad and tilt stand over, resting it on a flat surface so you are looking at the bottom of the tilt stand.

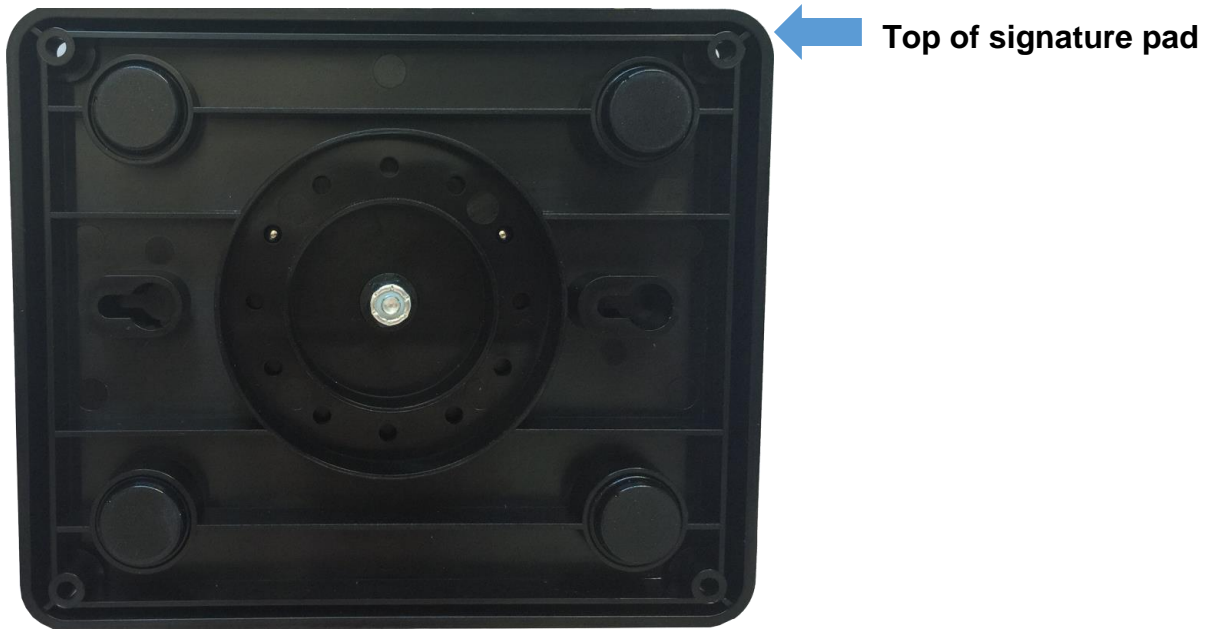

- 6) Physically turn the bottom of tilt stand 180 degrees so it is vertical instead of horizontal. This will provide easier access to the screw holes using a screw driver (see Steps 7 and 8 on Pages 7 and 8).

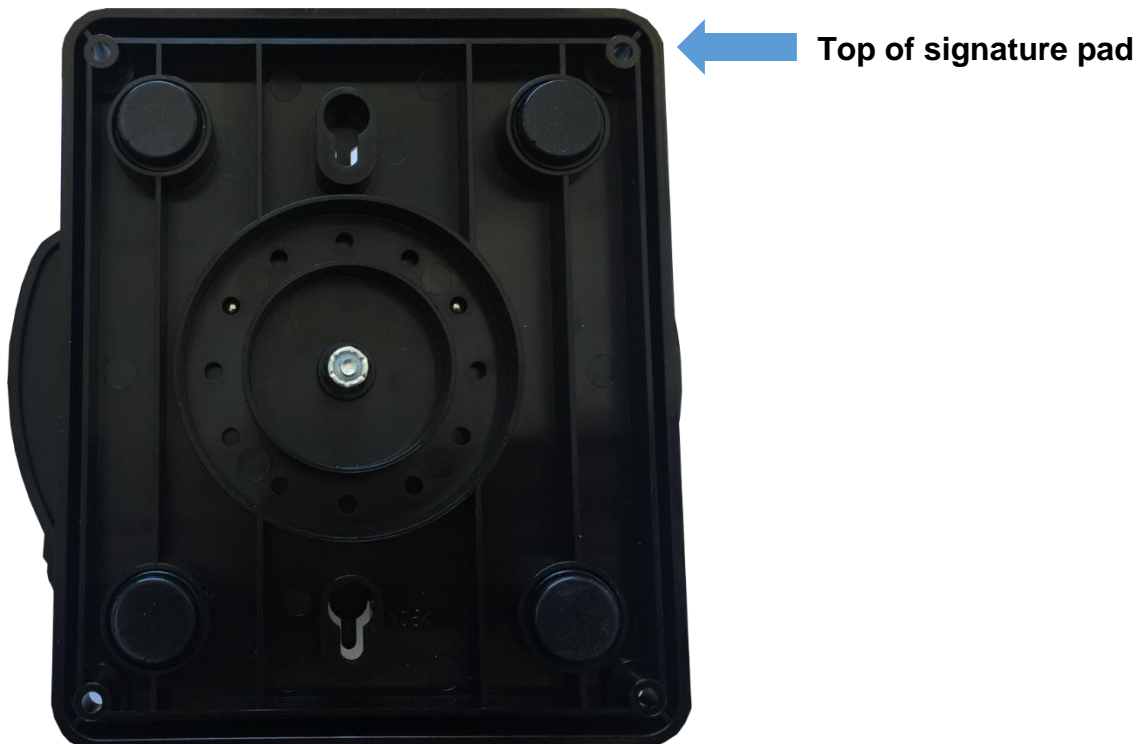

- 7) Use the two small silver screws (removed in Step 4 on Page 5) and two medium plastite screws included in the hardware kit (see Page 3 for picture). Begin on the right side, as seen below:

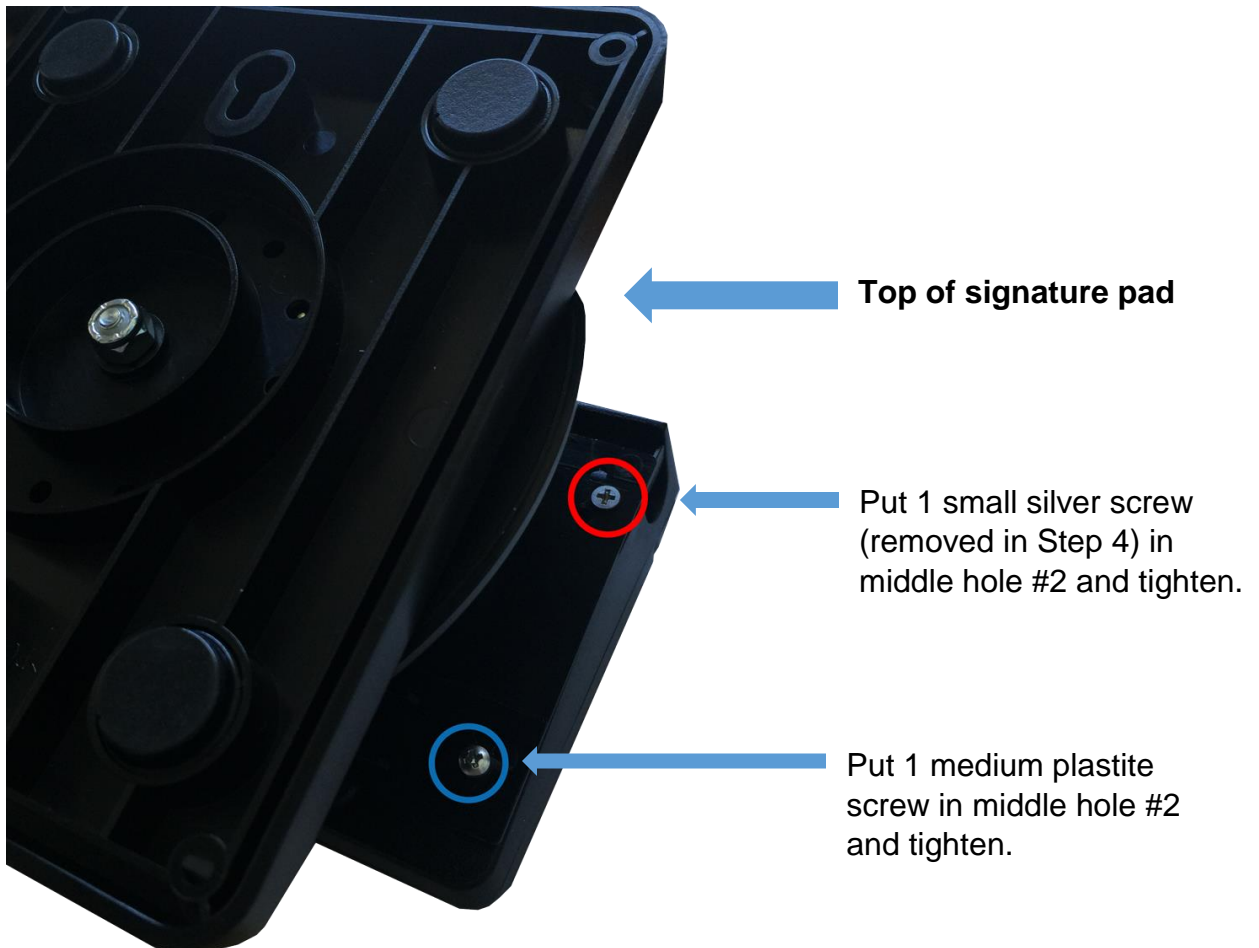

8) Continue with the left side.



9) Your signature pad is now mounted on the tilt stand.



## Surface Mounting Instructions

- 1) Using a 3/16-in drill bit (not included), drill holes into the surface on which you want to mount the tilt stand (see diagram below).

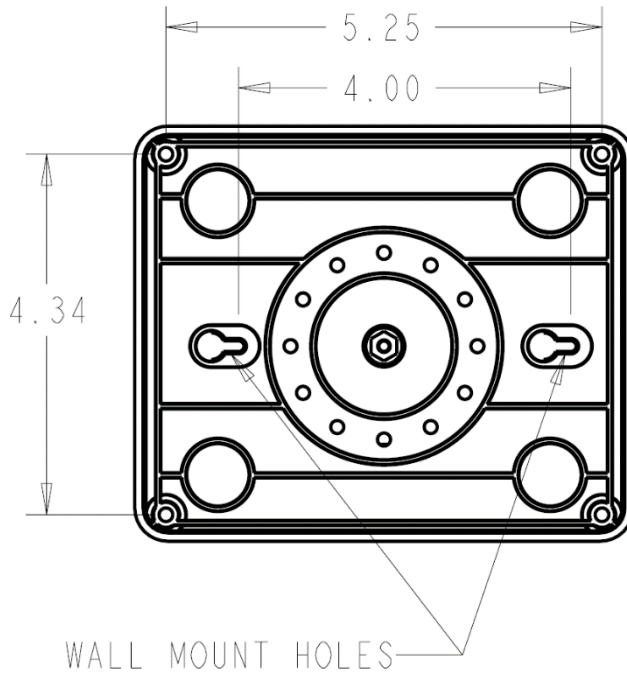

- 2) Remove the four rubber feet from the bottom of the tilt stand. The rubber feet are attached to the tilt stand with a light adhesive, so use a thin item to pry them off.
- 3) Use the long panhead screws, small nuts, and small split washers (see Page 3 for pictures) from the included hardware kit to attach the tilt stand to the surface, placing the small split washers in between the surface and the small nuts.