



Tilt Stand Mounting Guide

TF-LBK463 & TF-LBK464 Models

Copyright © Topaz Systems Inc. All rights reserved.

For Topaz Systems, Inc. trademarks and patents, visit www.topazsystems.com/legal.

Table of Contents

Overview.....	3
List of Included Parts	3
Pad Mounting Instructions	4
Surface Mounting Instructions.....	9

Overview

The Topaz Tilt Stand (A-TSL1-1) is designed to hold Topaz LCD signature pads. If desired, the stand can be securely mounted on either the counter or the wall. With the tilt stand's 360 degree rotation and up-to-45 degree tilt, your signature pad can be easily positioned during the signing process.

The tilt stand can be used with the following pads (model numbers beginning with):







T-L460, T-LBK460 (SigLite LCD 1x5)	T-LBK755 (SignatureGem LCD 4x3)
TM-LBK460 (SigLite LCD 1x5 MSR)	TM-LBK755 (SignatureGem LCD 4x3 MSR)
T-L462, T-LBK462 (SignatureGem LCD 1x5)	T-LBK766 (SignatureGem LCD 4x5)
TF-LBK463 (IDLite LCD 1x5)	TM-LBK766 (SignatureGem LCD 4x5 MSR)
TF-LBK464 (IDGem LCD 1x5)	T-LBK57GC (SigGem Color 5.7)
T-LBK750 (SigLite LCD 4x3)	TM-LBK57GC (SigGem Color 5.7 MSR)
TM-LBK750 (SigLite LCD 4x3 MSR)	T-LBK43LC (SigLite Color 4.3)

To view the mounting guides for the different signature pad models listed above, visit the page www.topazsystems.com/tsguides, and select the correct mounting guide for your model number (listed on the back of your signature pad).

List of Included Parts

The following parts are included with the Topaz Tilt Stand.

Note: Not all parts will be used with all signature pad models.

	4x - Long Panhead Screw (For Surface Mounting)
	4x – Medium Plastite Screw
	4x – Small Flathead Screw
	4x – Small Nut (For Surface Mounting)
	4x – Small Split Washer (For Surface Mounting)
	1x – Allen Key

Pad Mounting Instructions

- 1) The following instructions are for use with the specific signature pad models listed below:

TF-LBK463-HSB-R

TF-LBK464-HSB-R

If you have a different model number listed on the back of your signature pad (see Page 3 for compatible model numbers), visit www.topazsystems.com/tsguides for all mounting guides.

- 2) Determine which mounting holes to use on the tilt stand. For the model numbers listed above in Step 1, use the four top holes labeled “1” in the diagram below.

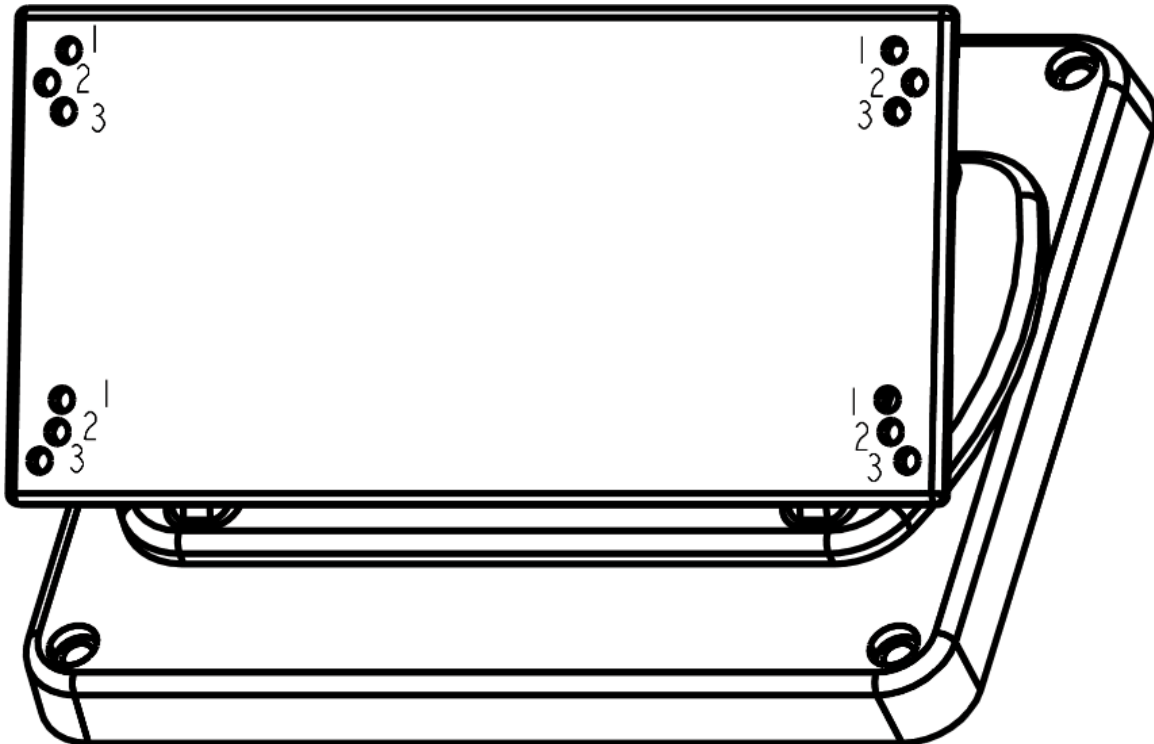

- 3) Remove the four rubber feet from the back of the pad to reveal the four screws underneath. The rubber feet are attached to the pad with a light adhesive, so use something thin to pry them off. Be sure to save the four rubber feet for the next step.

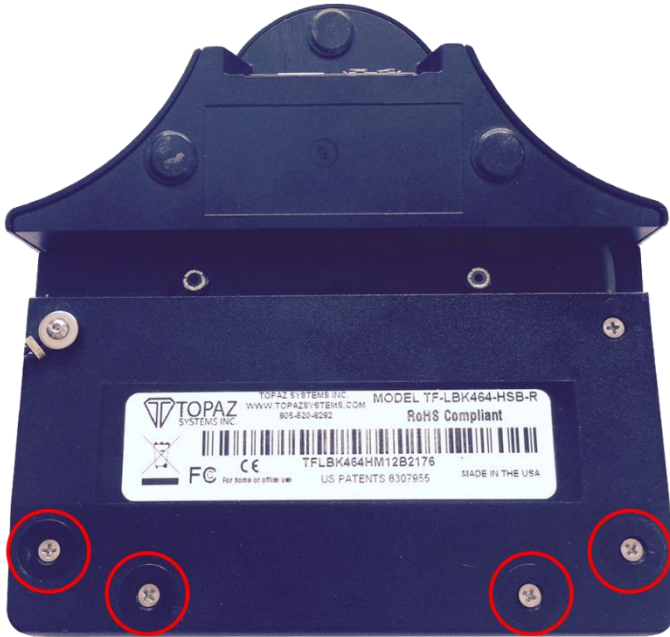

- 4) Take the four rubber feet and stack one on top of the other to create two stacks of two rubber feet. Then, place them near the bottom of the back of the pad (in between the screws) and press firmly. These will serve as spacers when mounting the pad on the tilt stand.

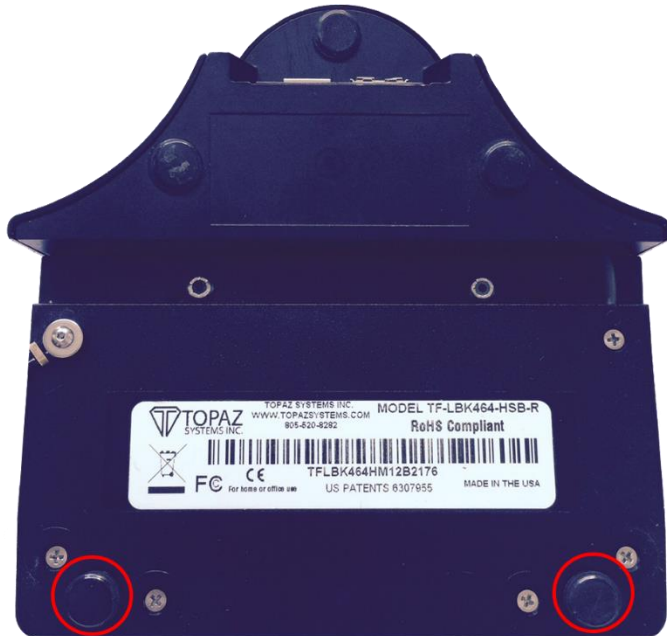

- Using a small Phillips screwdriver (not included), remove the three screws circled in red below. Using the small Allen key included with this kit (see Page 3 for picture), remove the screw, flat washer, and small plastic spacer tethering the pen to the signature pad (area circled in blue below).

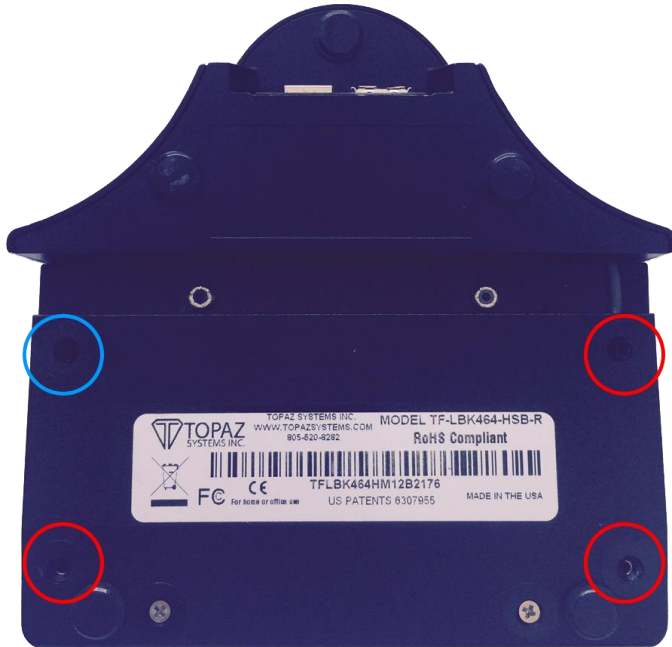

- Lay the signature pad on the top of the tilt stand as it would be if in use. Then, flip both the signature pad and tilt stand over, resting it on a flat surface so you are looking at the bottom of the tilt stand.

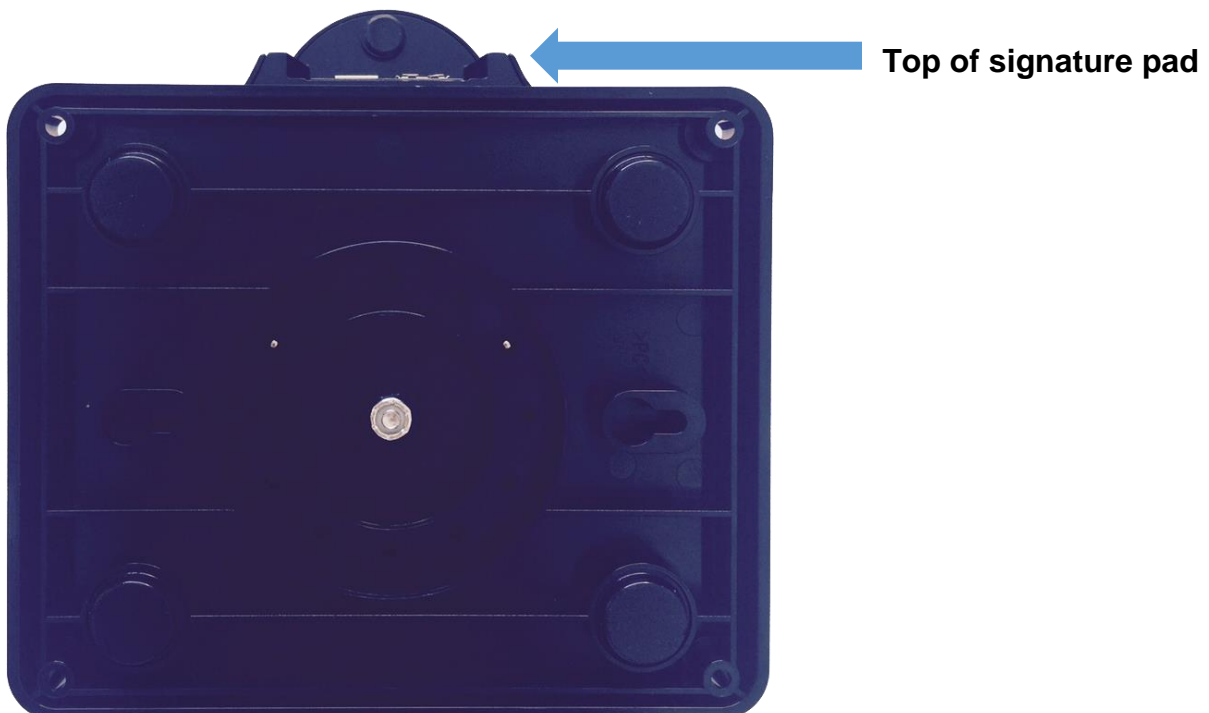

- 7) Physically turn the bottom of tilt stand 180 degrees so it is vertical instead of horizontal. This will provide easier access to the screw holes using a screw driver (see Steps 8 and 9 on Pages 7 and 8).

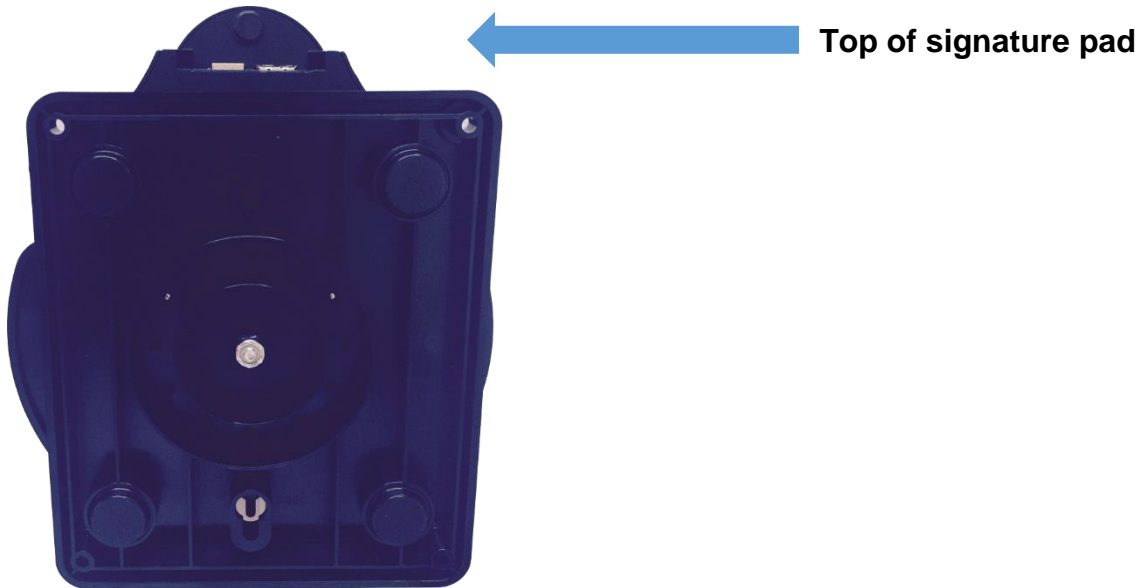

- 8) Use the four medium plastite screws included in the hardware kit (see Page 3 for picture). Begin on the right side, as seen below:

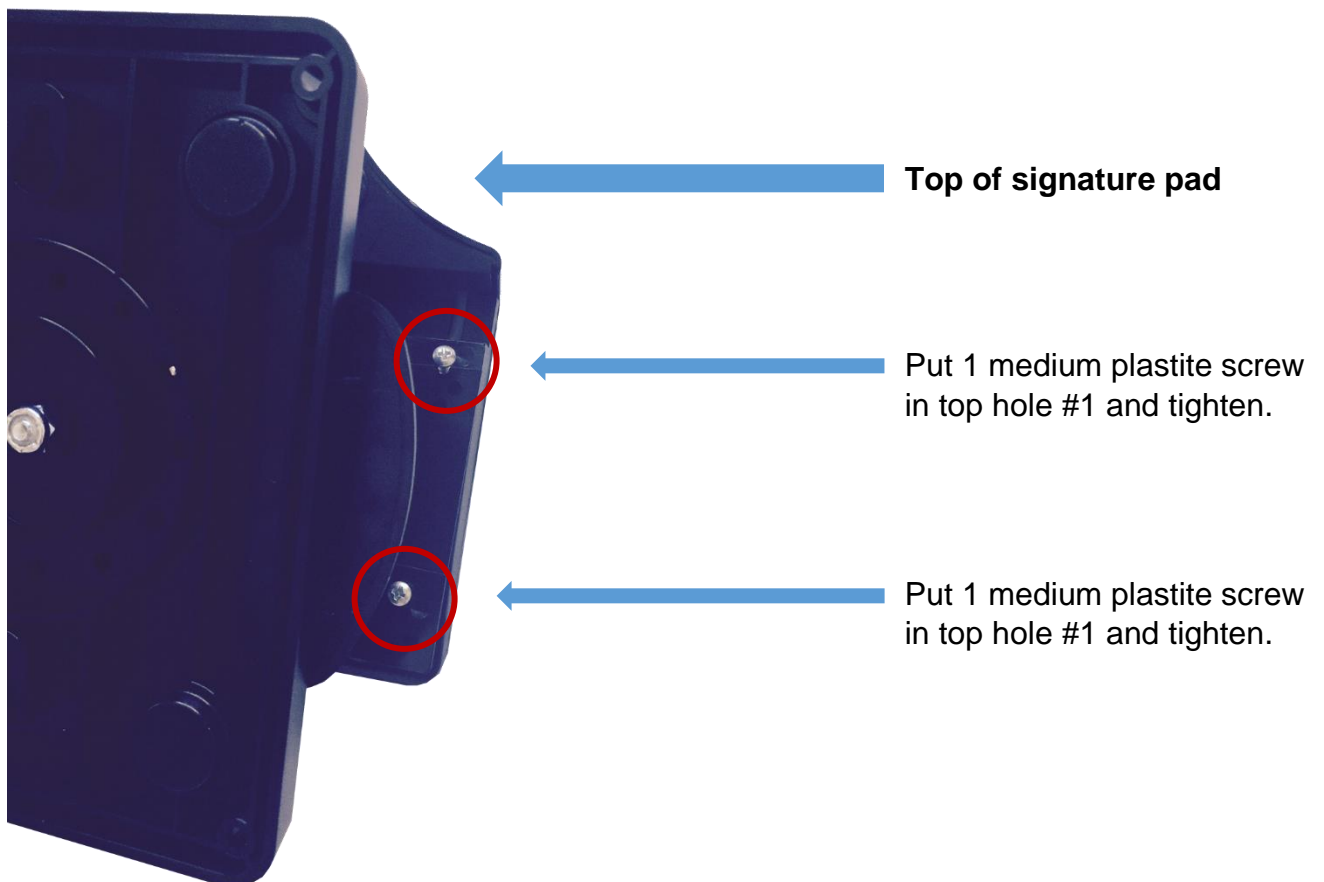

9) Continue with the left side.

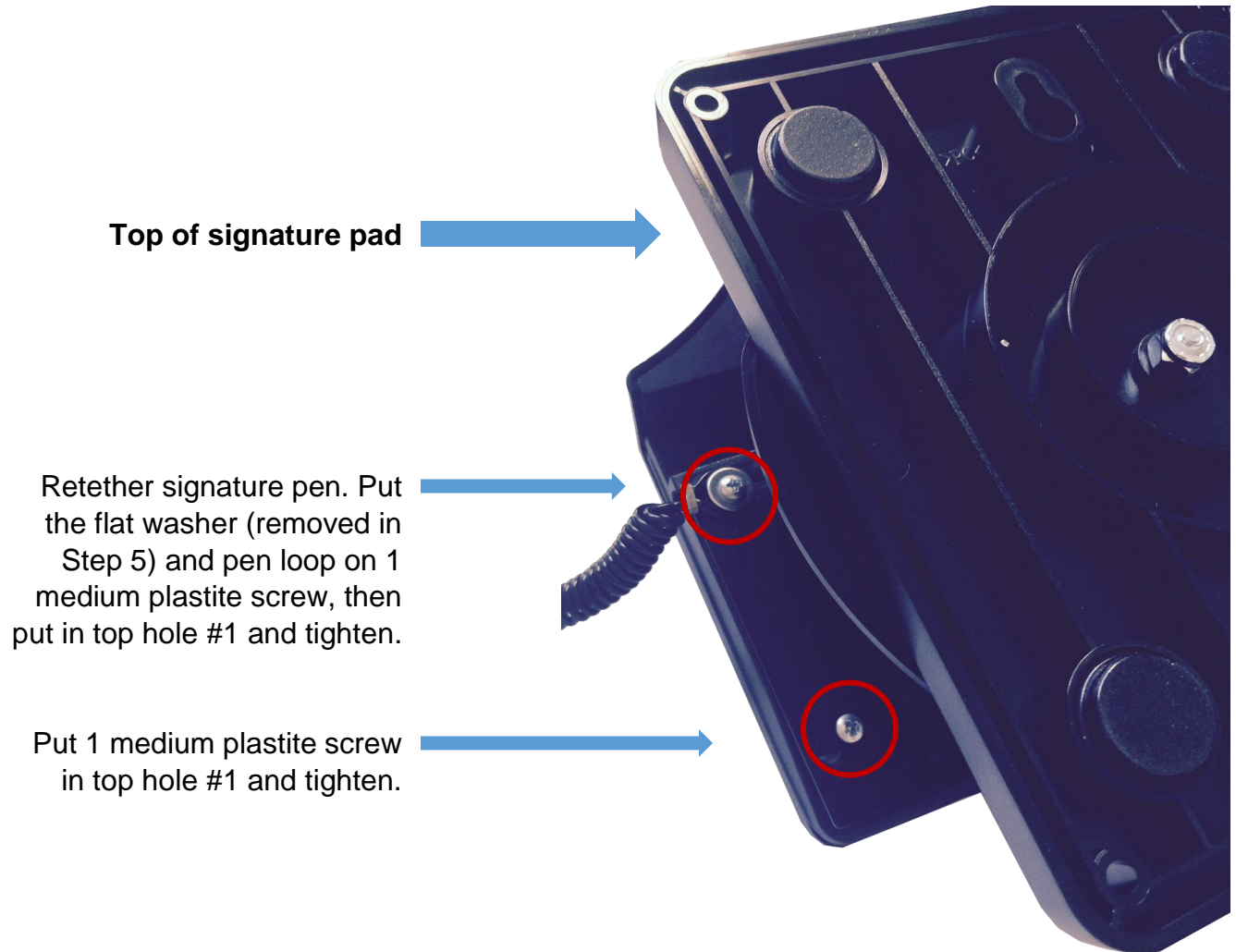

10) Your signature pad is now mounted on the tilt stand.

Surface Mounting Instructions

- 1) Using a 3/16-in drill bit (not included), drill holes into the surface on which you want to mount the tilt stand (see diagram below).

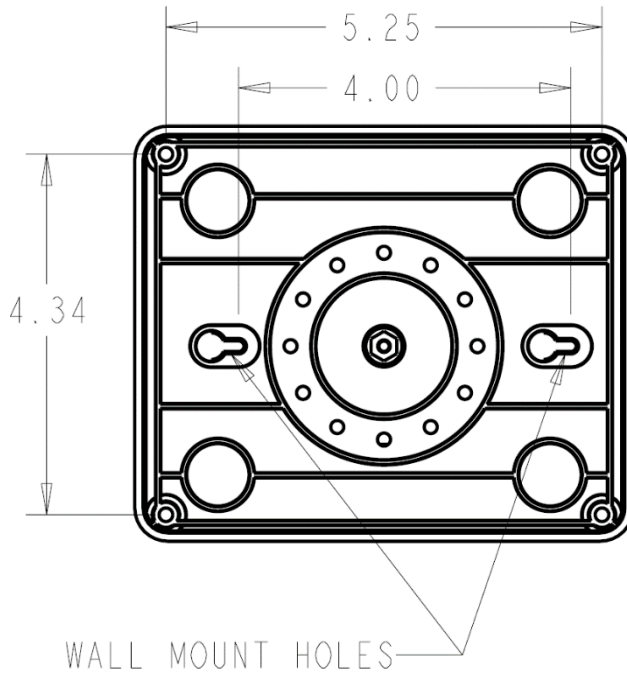

- 2) Remove the four rubber feet from the bottom of the tilt stand. The rubber feet are attached to the tilt stand with a light adhesive, so use a thin item to pry them off.
- 3) Use the long panhead screws, small nuts, and small split washers (see Page 3 for pictures) from the included hardware kit to attach the tilt stand to the surface, placing the small split washers in between the surface and the small nuts.